

Banner size: 33.5" x 78.7"

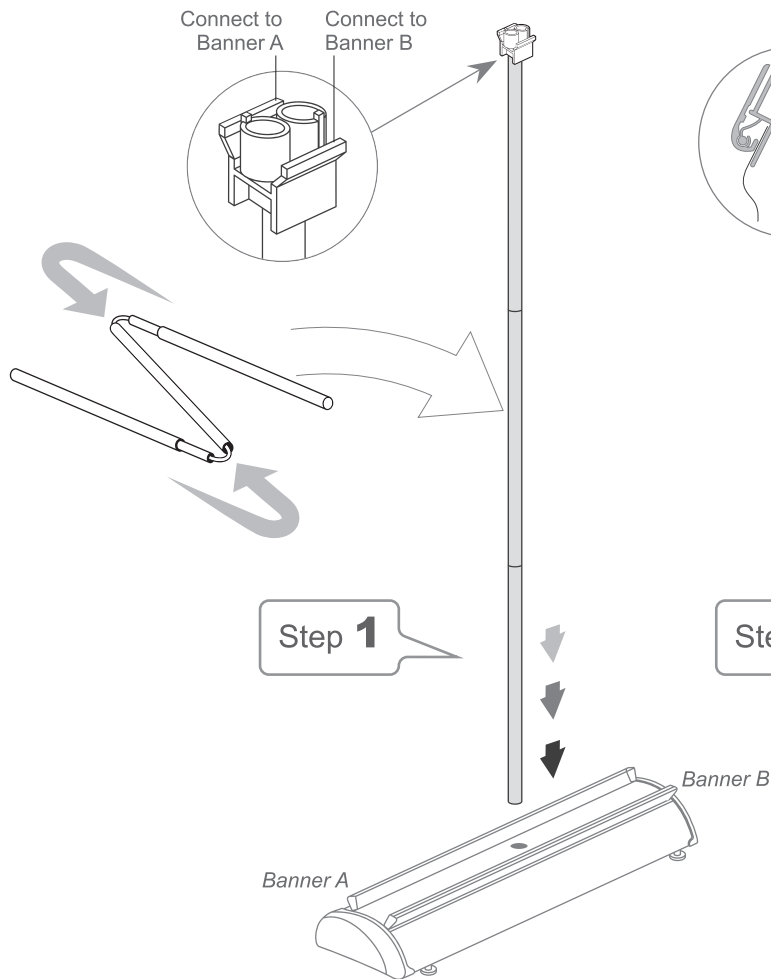

Connect the 3 segments of the support pole together and insert the pole into the center hole in the base of the stand. Make sure to rotate the pole so the top cap is positioned as shown.

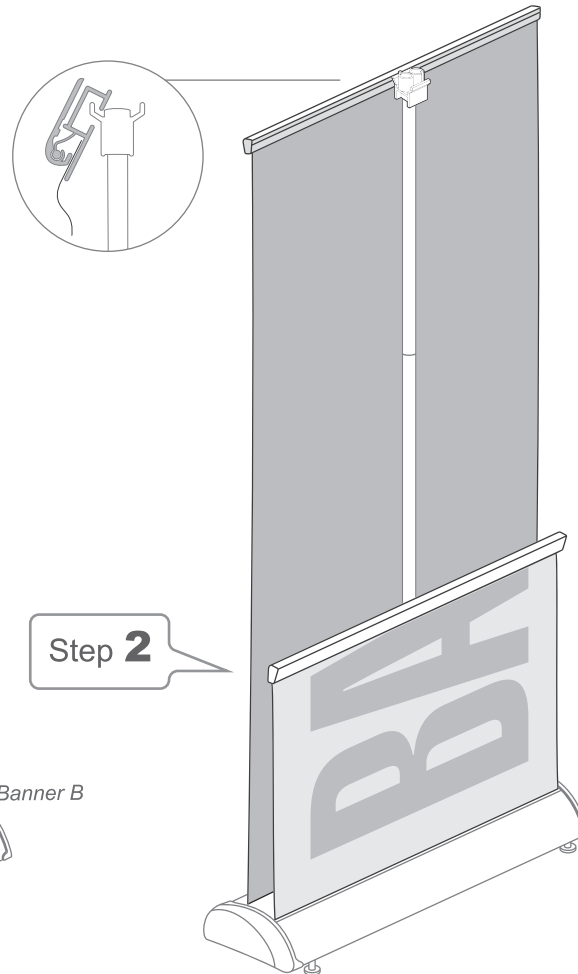

Pull the banner up from the base and connect the top cap of the pole to the top rail, making sure to align the pole to the sticker marked "INSERT." Repeat this step for the remaining banner.

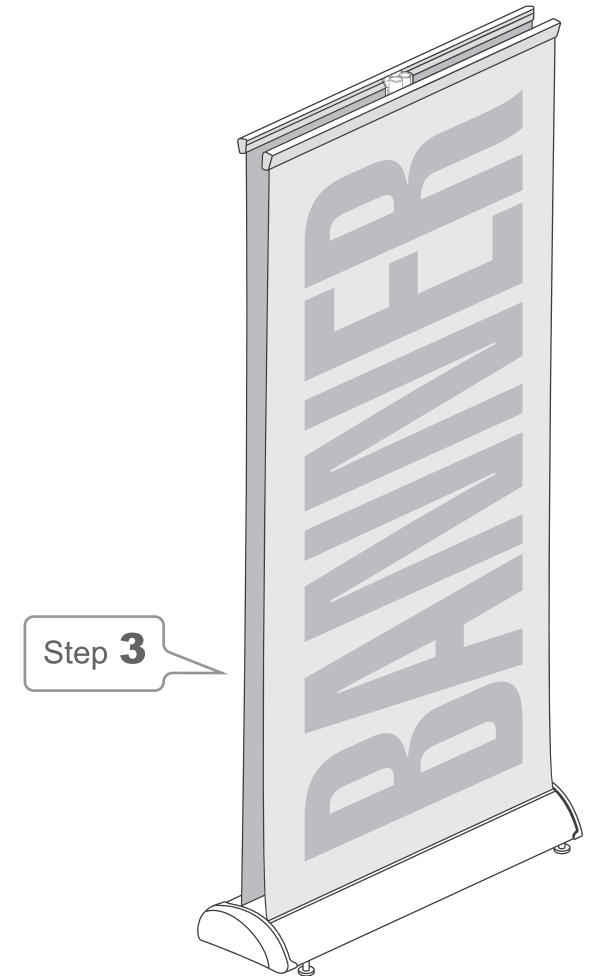

Start promoting your message!

**Simply reverse this process to take down the stand.**

# Premium II

2-SIDED BANNER STANDS

## Banner REPLACEMENT Instructions

OPTIONAL

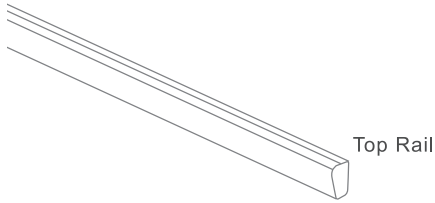

### TOOLS REQUIRED

- Flat-head screwdriver
- Scissors or a cutter
- Double-sided tape

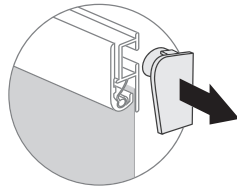
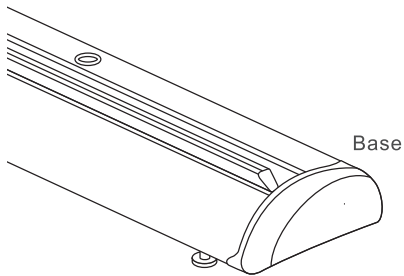

**Step 1**  
Remove the top rail end caps.

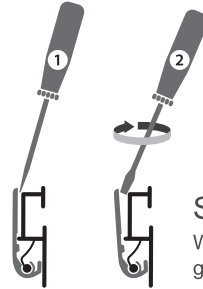

**Step 2**  
With a flat-head screwdriver, gently push against the top rail.

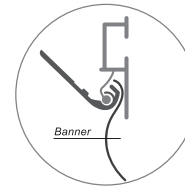
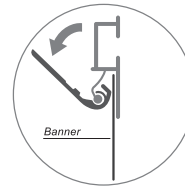

**Step 3**  
Open the top rail to release the old banner.

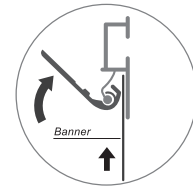

**Step 4**  
Insert the new banner and close the top rail to secure the banner. Attach the end caps to the rail.

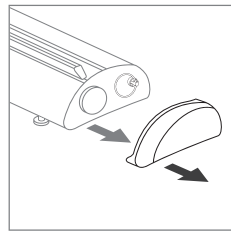

**Step 1**  
Remove the base end caps.

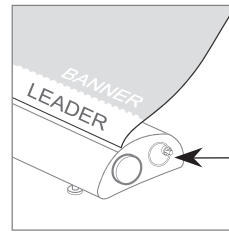

**Step 2**  
Gently pull the banner up until it is fully extended and you can see the leader, which is the white area on the bottom of the banner.



**Step 3**  
Find the handle on the side of the base and pull it slightly out, then twist and lock into the lock position. This will prevent your banner from retracting into the base.

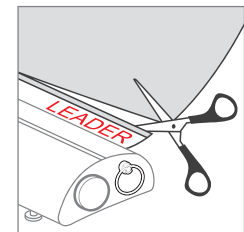

**Step 4**  
Cut along the bottom of the banner with scissors or a cutter, making sure to cut about an inch above the leader.

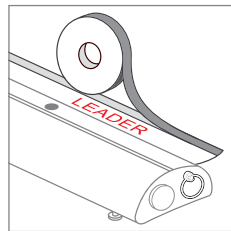

**Step 5**  
Align the double-sided tape so that it runs straight across the banner, right above the leader. Apply the tape, making sure to run your hand across the tape to ensure it adheres to the banner.

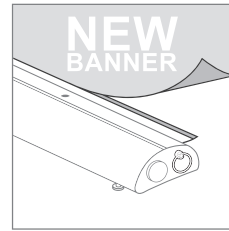

**Step 6**  
Attach the banner onto the tape, making sure to attach right above the leader. Run your hand across the bottom of the banner to ensure the banner has adhered to the tape.

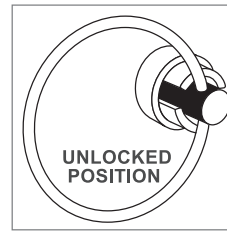

**Step 7**  
While holding onto the banner tightly, pull the handle, then twist until the handle is in the unlocked position.

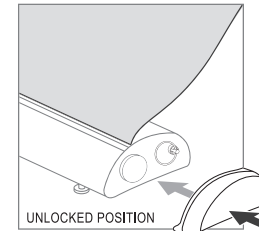

**Step 8**  
Once in the unlocked position, gently and slowly allow the banner to retract back into the stand. Don't forget to attach the end caps to the base. You are now ready to install the banner to the pole and display your message!

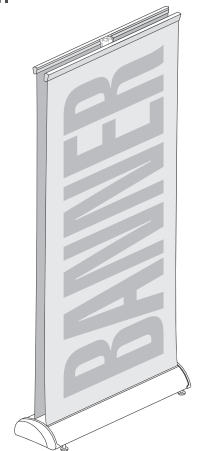

**Make sure to repeat all the above steps for the remaining banner.**